

**Features**

- $BV_{CEO} > 160V$
- $BV_{EBO} > 6V$
- $I_C = 600mA$  Continuous Collector Current
- Low Saturation Voltage (150mV max @10mA)
- $h_{FE}$  specified up to 50mA for a high gain hold up
- Complementary PNP Type: DZT5401
- **Totally Lead-Free & Fully RoHS Compliant (Notes 1 & 2)**
- **Halogen and Antimony Free. "Green" Device (Note 3)**
- **Qualified to AEC-Q101 Standards for High Reliability**

**Mechanical Data**

- Case: SOT223
- Case material: molded plastic. "Green" molding compound.
- UL Flammability Rating 94V-0
- Moisture Sensitivity: Level 1 per J-STD-020
- Terminals: Finish - Matte Tin Plated Leads, Solderable per MIL-STD-202, Method 208 
- Weight: 0.112 grams (approximate)

**Applications**

- High Voltage Amplification Applications
- High Voltage Switching

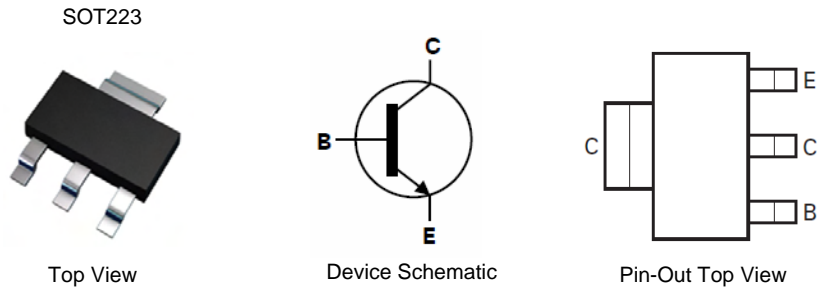

**Ordering Information** (Note 4)

Part Number	Marking	Reel size (inches)	Tape width (mm)	Quantity per reel
DZT5551-13	K4N	13	12	2,500

- Notes:
1. No purposely added lead. Fully EU Directive 2002/95/EC (RoHS) & 2011/65/EU (RoHS 2) compliant.
  2. See <http://www.diodes.com> for more information about Diodes Incorporated's definitions of Halogen and Antimony free, "Green" and Lead-Free.
  3. Halogen and Antimony free "Green" products are defined as those which contain <900ppm bromine, <900ppm chlorine (<1500ppm total Br + Cl) and <1000ppm antimony compounds.
  4. For packaging details, go to our website at <http://www.diodes.com>

**Marking Information**

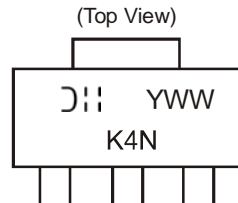

K4N = Product type marking code  
 DII = Manufacturer's code marking  
 YWW = Date code marking  
 Y = Last digit of year ex: 7 = 2007  
 WW = Week code 01 - 52

---

**Maximum Ratings** (@T<sub>A</sub> = +25°C, unless otherwise specified.)

Characteristic	Symbol	Value	Unit
Collector-Base Voltage	V <sub>CB0</sub>	180	V
Collector-Emitter Voltage	V <sub>CEO</sub>	160	V
Emitter-Base Voltage	V <sub>EBO</sub>	6	V
Continuous Collector Current	I <sub>C</sub>	600	mA
Peak Collector Current	I <sub>CM</sub>	1	A

---

**Thermal Characteristics**

Characteristic	Symbol	Value	Unit
Power Dissipation (Note 5)	P <sub>D</sub>	2	W
Thermal Resistance, Junction to Ambient (Note 5)	R <sub>θJA</sub>	62.5	°C/W
Thermal Resistance, Junction to Leads (Note 6)	R <sub>θJL</sub>	34.05	°C/W
Operating and Storage Temperature Range	T <sub>J</sub> , T <sub>STG</sub>	-55 to +150	°C

- Notes:
- 5. Device mounted on 50mm X 50mm X 1.6mm FR-4 PCB with high coverage of single sided 1 oz. copper, in still air condition
  - 6. Thermal resistance from junction to solder-point (at the end of the collector lead).

**Thermal Characteristics and Derating Information**

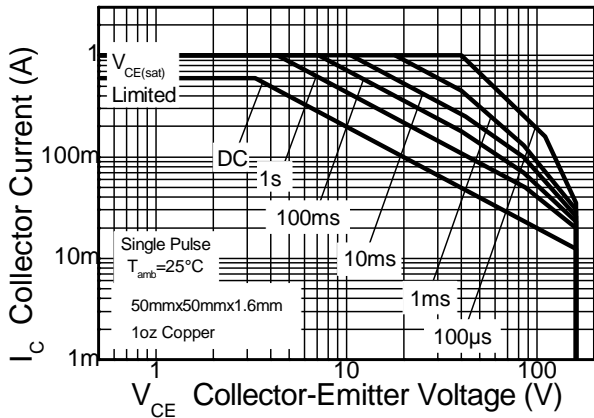

**Safe Operating Area**

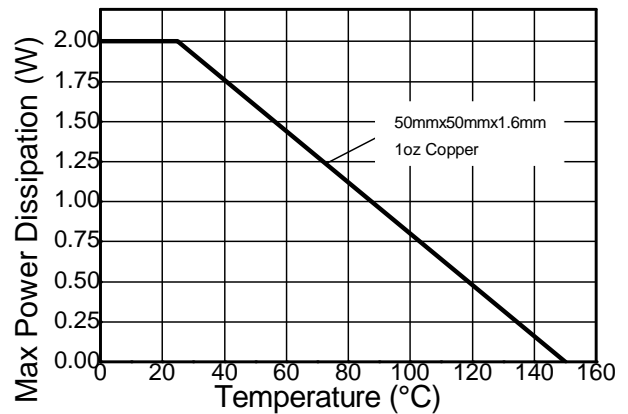

**Derating Curve**

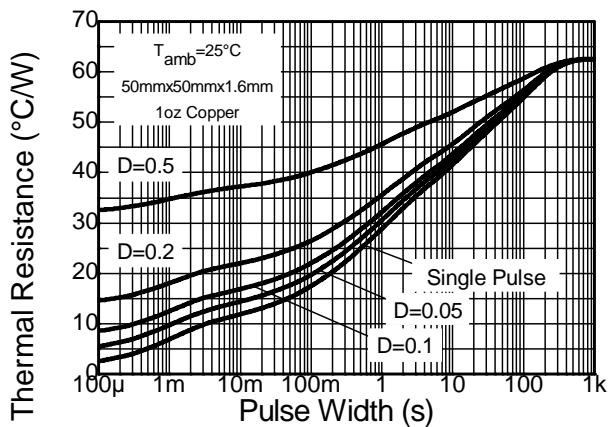

**Transient Thermal Impedance**

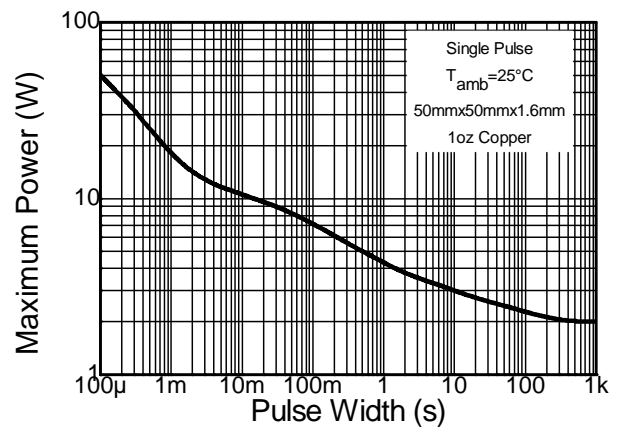

**Pulse Power Dissipation**

**Electrical Characteristics** (@T<sub>A</sub> = +25°C, unless otherwise specified.)

Characteristic	Symbol	Min	Typ	Max	Unit	Test Condition
<b>OFF CHARACTERISTICS</b>						
Collector-Base Breakdown Voltage	BV <sub>CBO</sub>	180	270	—	V	I <sub>C</sub> = 100μA, I <sub>E</sub> = 0
Collector-Emitter Breakdown Voltage (Note 7)	BV <sub>CEO</sub>	160	200	—	V	I <sub>C</sub> = 1mA, I <sub>B</sub> = 0
Emitter-Base Breakdown Voltage	BV <sub>EBO</sub>	6.0	7.85	—	V	I <sub>E</sub> = 100μA, I <sub>C</sub> = 0
Collector Cutoff Current	I <sub>CBO</sub>	—	<1	50	nA	V <sub>CB</sub> = 120V, I <sub>E</sub> = 0
Emitter Cutoff Current	I <sub>EBO</sub>	—	<1	50	nA	V <sub>CB</sub> = 120V, I <sub>E</sub> = 0, T <sub>A</sub> = +100°C
						V <sub>EB</sub> = 4V, I <sub>C</sub> = 0
<b>ON CHARACTERISTICS (Note 7)</b>						
Collector-Emitter Saturation Voltage	V <sub>CE(sat)</sub>	—	65	150	mV	I <sub>C</sub> = 10mA, I <sub>B</sub> = 1mA
		—	115	200	mV	I <sub>C</sub> = 50mA, I <sub>B</sub> = 5mA
Base-Emitter Saturation Voltage	V <sub>BE(sat)</sub>	—	760	1000	mV	I <sub>C</sub> = 10mA, I <sub>B</sub> = 1mA
		—	840	1200	mV	I <sub>C</sub> = 50mA, I <sub>B</sub> = 5mA
DC Current Gain	h <sub>FE</sub>	80	130	—	—	I <sub>C</sub> = 1mA, V <sub>CE</sub> = 5V
		80	145	250	—	I <sub>C</sub> = 10mA, V <sub>CE</sub> = 5V
		30	65	—	—	I <sub>C</sub> = 50mA, V <sub>CE</sub> = 5V
<b>SMALL SIGNAL CHARACTERISTICS</b>						
Transition Frequency	f <sub>T</sub>	100	130	300	MHz	V <sub>CE</sub> = 10V, I <sub>C</sub> = 10mA, f = 100MHz
Small Signal Current Gain	h <sub>fe</sub>	50	—	260	—	V <sub>CE</sub> = 10V, I <sub>C</sub> = 10mA, f = 1kHz
Output Capacitance	C <sub>obo</sub>	—	—	6	pF	V <sub>CB</sub> = 10V, f = 1MHz
Noise Figure	NF	—	—	8	dB	V <sub>CE</sub> = 5.0V, I <sub>C</sub> = 200μA, R <sub>S</sub> = 1.0kΩ, f = 1.0kHz
Delay Time	t <sub>(d)</sub>	—	95	—	ns	V <sub>CC</sub> = 10V, I <sub>C</sub> = 10mA, I <sub>B1</sub> = -I <sub>B2</sub> = 1mA
Rise Time	t <sub>(r)</sub>	—	64	—	ns	
Storage Time	t <sub>(s)</sub>	—	1256	—	ns	
Delay Time	t <sub>(f)</sub>	—	140	—	ns	

Notes: 7. Pulse Test: Pulse width ≤ 300μs. Duty cycle ≤ 2.0%.

**Typical Electrical Characteristics** (@T<sub>A</sub> = +25°C, unless otherwise specified.)

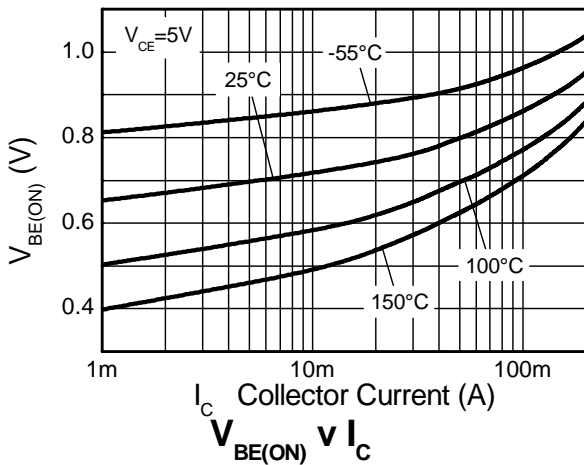
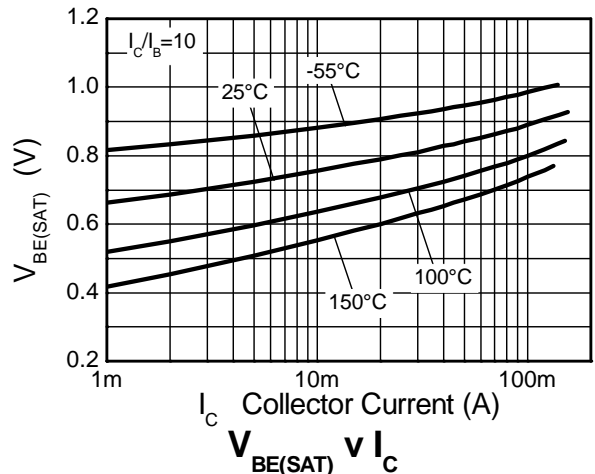
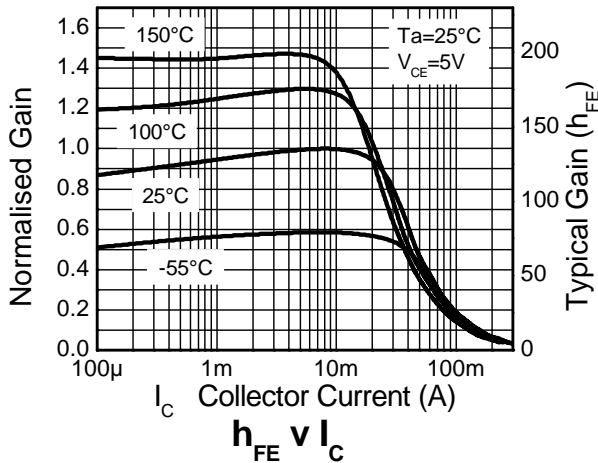
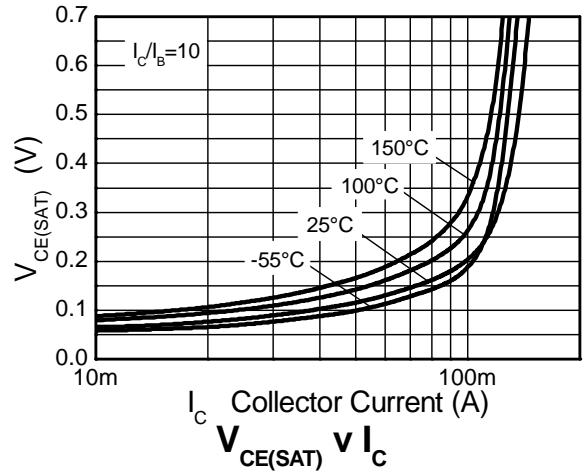
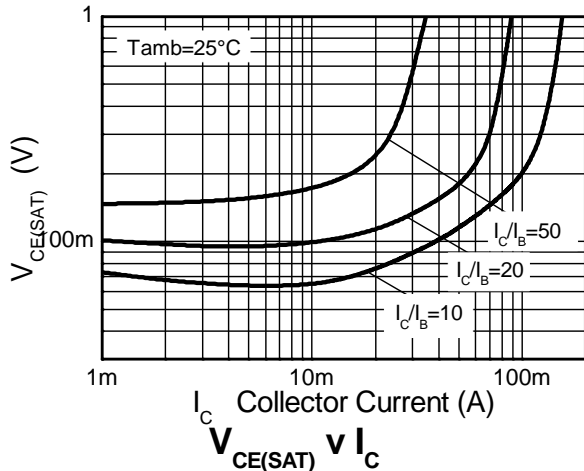

**Package Outline Dimensions**

Please see AP02002 at <http://www.diodes.com/datasheets/ap02002.pdf> for latest version.

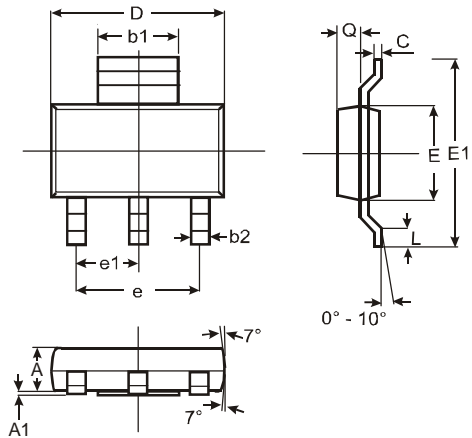

SOT223			
Dim	Min	Max	Typ
A	1.55	1.65	1.60
A1	0.010	0.15	0.05
b1	2.90	3.10	3.00
b2	0.60	0.80	0.70
C	0.20	0.30	0.25
D	6.45	6.55	6.50
E	3.45	3.55	3.50
E1	6.90	7.10	7.00
e	—	—	4.60
e1	—	—	2.30
L	0.85	1.05	0.95
Q	0.84	0.94	0.89
All Dimensions in mm			

**Suggested Pad Layout**

Please see AP02001 at <http://www.diodes.com/datasheets/ap02001.pdf> for the latest version.

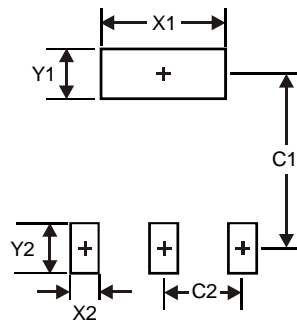

Dimensions	Value (in mm)
X1	3.3
X2	1.2
Y1	1.6
Y2	1.6
C1	6.4
C2	2.3

**IMPORTANT NOTICE**

DIODES INCORPORATED MAKES NO WARRANTY OF ANY KIND, EXPRESS OR IMPLIED, WITH REGARDS TO THIS DOCUMENT, INCLUDING, BUT NOT LIMITED TO, THE IMPLIED WARRANTIES OF MERCHANTABILITY AND FITNESS FOR A PARTICULAR PURPOSE (AND THEIR EQUIVALENTS UNDER THE LAWS OF ANY JURISDICTION).

Diodes Incorporated and its subsidiaries reserve the right to make modifications, enhancements, improvements, corrections or other changes without further notice to this document and any product described herein. Diodes Incorporated does not assume any liability arising out of the application or use of this document or any product described herein; neither does Diodes Incorporated convey any license under its patent or trademark rights, nor the rights of others. Any Customer or user of this document or products described herein in such applications shall assume all risks of such use and will agree to hold Diodes Incorporated and all the companies whose products are represented on Diodes Incorporated website, harmless against all damages.

Diodes Incorporated does not warrant or accept any liability whatsoever in respect of any products purchased through unauthorized sales channel. Should Customers purchase or use Diodes Incorporated products for any unintended or unauthorized application, Customers shall indemnify and hold Diodes Incorporated and its representatives harmless against all claims, damages, expenses, and attorney fees arising out of, directly or indirectly, any claim of personal injury or death associated with such unintended or unauthorized application.

Products described herein may be covered by one or more United States, international or foreign patents pending. Product names and markings noted herein may also be covered by one or more United States, international or foreign trademarks.

This document is written in English but may be translated into multiple languages for reference. Only the English version of this document is the final and determinative format released by Diodes Incorporated.

**LIFE SUPPORT**

Diodes Incorporated products are specifically not authorized for use as critical components in life support devices or systems without the express written approval of the Chief Executive Officer of Diodes Incorporated. As used herein:

A. Life support devices or systems are devices or systems which:

1. are intended to implant into the body, or
2. support or sustain life and whose failure to perform when properly used in accordance with instructions for use provided in the labeling can be reasonably expected to result in significant injury to the user.

B. A critical component is any component in a life support device or system whose failure to perform can be reasonably expected to cause the failure of the life support device or to affect its safety or effectiveness.

Customers represent that they have all necessary expertise in the safety and regulatory ramifications of their life support devices or systems, and acknowledge and agree that they are solely responsible for all legal, regulatory and safety-related requirements concerning their products and any use of Diodes Incorporated products in such safety-critical, life support devices or systems, notwithstanding any devices- or systems-related information or support that may be provided by Diodes Incorporated. Further, Customers must fully indemnify Diodes Incorporated and its representatives against any damages arising out of the use of Diodes Incorporated products in such safety-critical, life support devices or systems.

Copyright © 2012, Diodes Incorporated

[www.diodes.com](http://www.diodes.com)